

Compact CPX 620 Specifications

- **Unique Double-Edge profile and corner radii.** Sink lies completely flat on worktop and cloths will not snag on corners
- **2 x 90mm Wastes with Basket Strainer Waste.** Capable of adaptation to take Waste Disposal Unit
- **3 colours of bespoke accessories available**
- **Classic Compact Franke design**
- **2 bowl configuration**

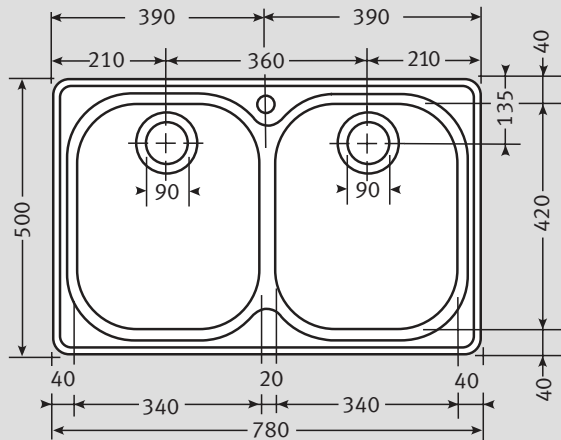

Material: 304 Austenitic 18/10 Stainless Steel

Application: Inset or undermount

Bowl size: 340 x 420 x 175 (x 2)
(Bowls welded to frame)

Drainer Format: Not applicable

Cut-out size: 764 x 484 (cr=20)

Colour: Silk Stainless Steel

Seal: Factory Fitted Polyurethane Seal

Insulation: Grey Dynaphon for heat and sound

Heat Resistance: Up to 300°C

Earthing Point: Located at end of clip rail

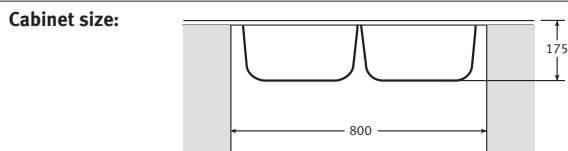

Sink Profile: Double Edge

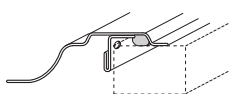

Fixing Clips: 'S' rail

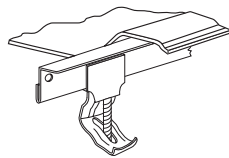

Suggested Plumbing Kit: 2 part

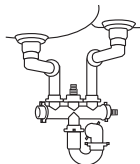

Waste: 1 x Lira 90mm Basket Strainer Waste with overflow
1 x Lira 90mm Basket Strainer Waste

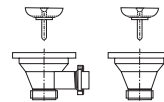

Overflow:



Accessories available:



Drainer Tray
Available in White, Almond, Brown or Black

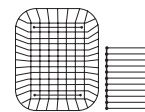

Drainer Basket/Plate Rack
Available in White, Almond, Brown or Black

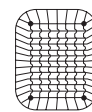

Drainer Basket
Stainless Steel



Food Preparation Platter
Mahogany



Food Preparation Platter
Hygenia

Taps: Any Franke tap can be utilised with this model*.

*Ceramic disc taps in certain installations or where there is a low head of water (below 4 metres) may not provide adequate flow rates. You are advised to check with your supplier.

Some taps may need bracing to avoid flexing of the sink ledge.

Guarantee: Franke sinks are guaranteed for 25 years against manufacturing defect. Franke taps are guaranteed against defective materials and workmanship for 1 year in relation to coatings and finishes, and 5 years in relation to moving parts. Franke will replace (and where appropriate repair) defective sinks. In relation to taps, Franke will where appropriate provide replacement parts for your taps or replace your taps. Any associated or ancillary costs to be incurred by you as a result of replacement of Franke sinks and taps under this guarantee shall in all cases be previously approved by Franke UK Limited.

This guarantee is in addition to and does not affect your statutory rights.