

ARX 651 Specifications

- **Unique Double-Edge profile and corner radii.** Sink lies completely flat on worktop and cloths will not snag on corners
- **90mm Waste with Basket Strainer Waste.** Capable of adaptation to take Waste Disposal Unit
- **4 colours of bespoke accessories available**
- **Large diagonal bowl dimension**
- **Extra large main and half bowl located at front rim of sink profile**

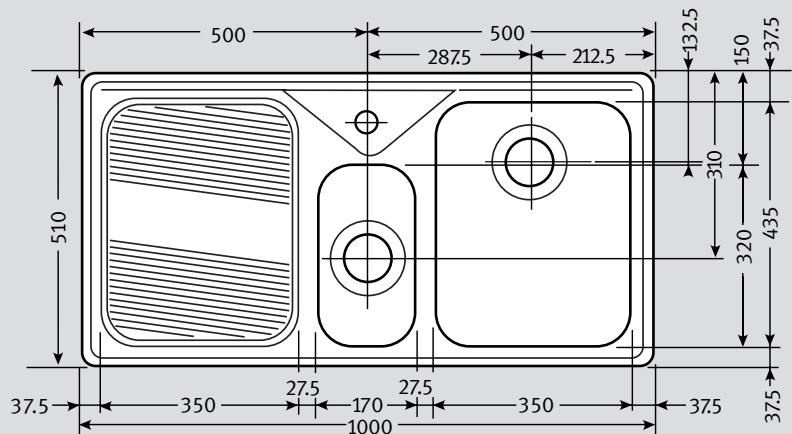

Material:	304 Austenitic 18/10 Stainless Steel
Application:	Inset or undermount
Bowl size:	350 x 435 x 180 } Bowls welded to frame 170 x 320 x 130 }
Drainer Format:	Left or right hand drainer available
Cut-out size:	984 x 494 (R=20)
Colour:	Silk Stainless Steel
Seal:	Factory Fitted Polyurethane Seal
Insulation:	Grey Dynaphon heat and sound
Heat Resistance:	Up to 300°C
Earthing Point:	Located at end of clip rail

Waste: 1 x Lira 90mm Basket Strainer Waste with overflow
1 x Lira 90mm Basket Strainer Wastes

Overflow:

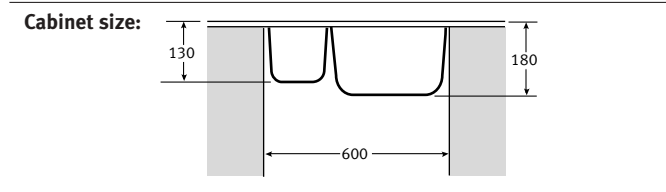
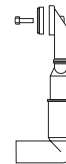
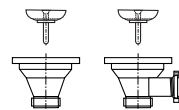

Accessories available:



Food Preparation Platter
Iroko
Large

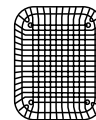

Drainer Basket
Available in
White, Almond,
Brown or Black

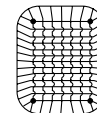

Drainer Basket
Stainless Steel

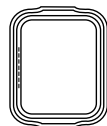

Drainer Tray
Available in
White, Almond,
Brown or Black



Drainer Tray
Stainless Steel



Strainer Bowl
Available in
White, Almond,
Brown or Black



Strainer Bowl
Stainless Steel

Sink Profile: Double Edge

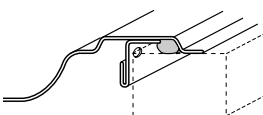

Fixing Clips: 'S' rail

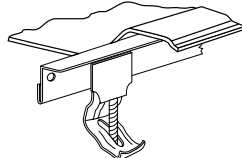

Suggested Plumbing Kit: 2 part

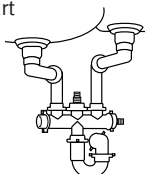

Taps: Any Franke tap can be utilised with this model*.

*Ceramic disc taps in certain installations or where there is a low head of water (below 4 metres) may not provide adequate flow rates. You are advised to check with your supplier.

Some taps may need bracing to avoid flexing of the sink ledge.

Guarantee: Franke sinks are guaranteed for 25 years against manufacturing defect. Franke taps are guaranteed against defective materials and workmanship for 1 year in relation to coatings and finishes, and 5 years in relation to moving parts. Franke will replace (and where appropriate repair) defective sinks. In relation to taps, Franke will where appropriate provide replacement parts for your taps or replace your taps. Any associated or ancillary costs to be incurred by you as a result of replacement of Franke sinks and taps under this guarantee shall in all cases be previously approved by Franke UK Limited.

This guarantee is in addition to and does not affect your statutory rights.