

Atlantis ALG 654 Specifications

- **2 x 90mm Wastes with Basket Strainer Wastes.** Capable of adaptation to take Waste Disposal Unit
- **Waste in half bowl positioned to rear**
- **4 colours of bespoke accessories available plus Stainless Steel**
- **Recessed drainer with dedicated convenient horizontal overflow**
- **Modern attractive design**
- **Large diagonal bowl dimension.** Extra large main and half bowl located at front rim of sink profile
- **Available as a Designer Value Pack**

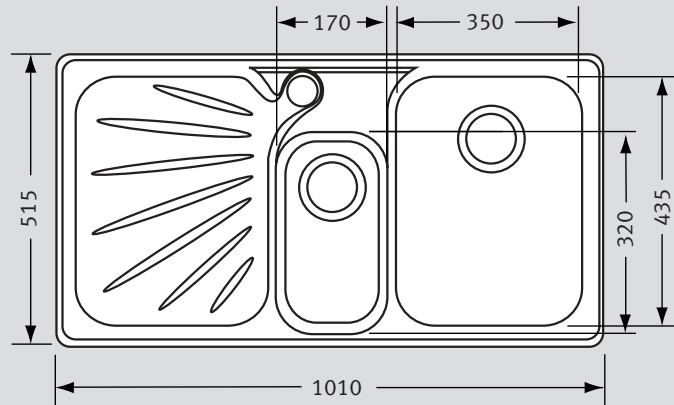

Material:	Fragranite fused silica/quartz composite
Application:	Inset
Bowl size:	350 x 435 x 180 170 x 320 x 135
Drainer Format:	Left or right hand available
Cut-out size:	990 x 495
Colour:	Fragranite SilkSheen: Polar White, Ivory, Platinum & Graphite
Seal:	Mastic Sealant
Insulation:	Integral
Heat Resistance:	Up to 280°C
Earthing Point:	Not applicable

Waste: 2 x Lira 90mm Basket Strainer Waste with overflow

Overflow:

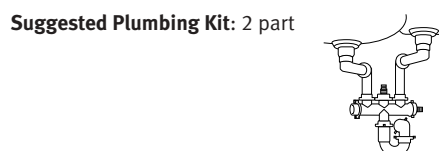
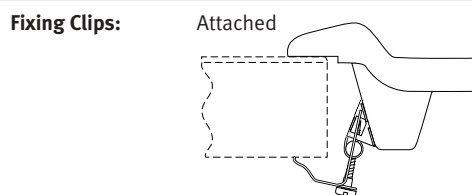
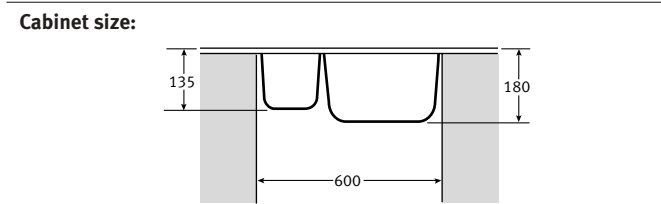
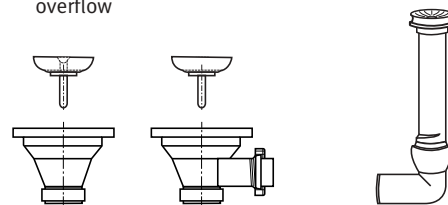

Accessories available:



Food Preparation Platter
Iroko Large

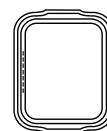

Drainer Tray
Available in White, Almond, Brown or Black



Strainer Bowl
Stainless Steel

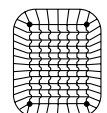

Drainer Basket
Stainless Steel

Taps: Any Franke tap can be utilised with this model*.

*Ceramic disc taps in certain installations or where there is a low head of water (below 4 metres) may not provide adequate flow rates. You are advised to check with your supplier.

Guarantee: Franke sinks are guaranteed for 25 years against manufacturing defect. Franke taps are guaranteed against defective materials and workmanship for 1 year in relation to coatings and finishes, and 5 years in relation to moving parts. Franke will replace (and where appropriate repair) defective sinks. In relation to taps, Franke will where appropriate provide replacement parts for your taps or replace your taps. Any associated or ancillary costs to be incurred by you as a result of replacement of Franke sinks and taps under this guarantee shall in all cases be previously approved by Franke UK Limited.

This guarantee is in addition to and does not affect your statutory rights.