

# Range ARX 754 Handed (1500) Specifications

- **High design concept**
- **2 x 90mm Wastes with Basket Strainer Wastes.** Capable of adaptation to take Waste Disposal Unit
- **Stainless Steel**
- **Convenient horizontal overflow**
- **Large diagonal bowl dimension.** Extra large main and a half bowl located at front rim of sink profile
- **Lipped wet area** to avoid spillage
- **Also available 1200mm\***
- **Available as Designer Value Pack**

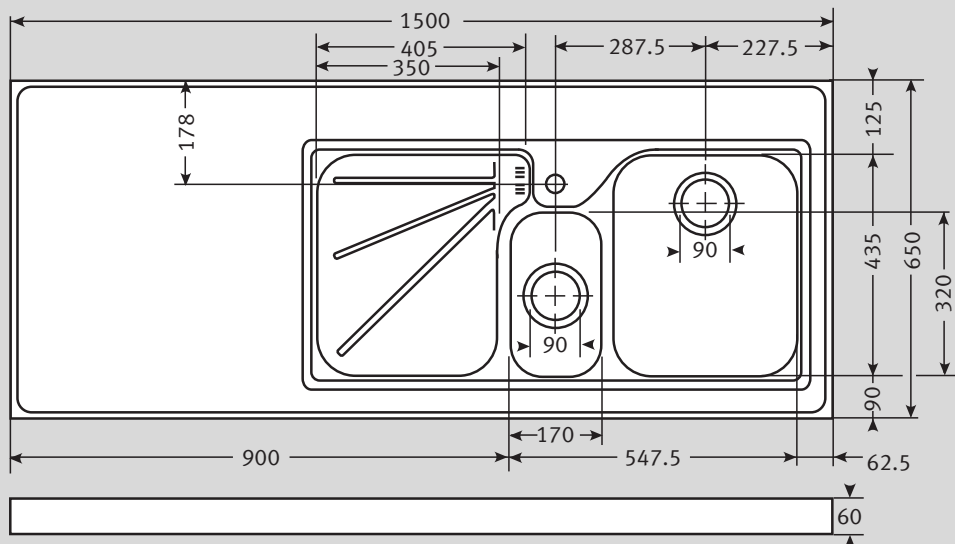

**Material:** Stainless Steel

**Application:** Specialised stand alone unit

**Bowl size:** 350 x 435 x 180 } Bowls welded to frame  
170 x 320 x 135 }

**Drainer Format:**

Left hand drainer

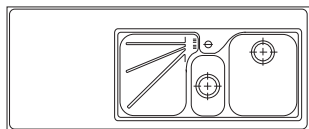

Right hand drainer

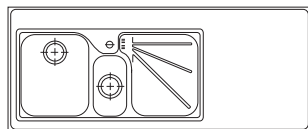

**Cut-out size:** N/A

**Colour:** Silk Stainless Steel

**Seal:** N/A

**Insulation:** Grey Dynaphon for heat and sound and water resistant chipboard V100 E1 backing

**Heat Resistance:** Up to 300°C

**Earthing Point:** Utilise frame

**Cabinet size:** Bespoke to size of unit (Min 600 base)

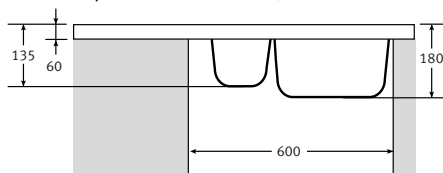

**Fixing Clips:** Not applicable

**Suggested Plumbing Kit:** 2 Part

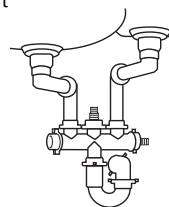

**Waste:** 1 x Lira 90mm Basket Strainer Waste with overflow  
1 x Lira 90mm Basket Strainer Wastes

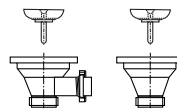

**Overflow:**



**Accessories available:**

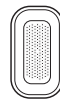

**Strainer Bowl**  
Available in White, Almond, Brown or Black

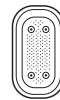

**Strainer Bowl**  
Stainless Steel



**Drainer Tray**  
Available in White, Almond, Brown or Black



**Drainer Tray**  
Stainless Steel

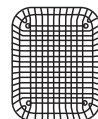

**Drainer Basket**  
Available in White, Almond, Brown or Black

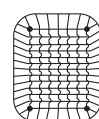

**Drainer Basket**  
Stainless Steel



**Food Preparation Platter**  
Iroko Large

**Taps:** Any Franke tap can be utilised with this model\*.

\*Ceramic disc taps in certain installations or where there is a low head of water (below 4 metres) may not provide adequate flow rates. You are advised to check with your supplier.

**Guarantee:** Franke sinks are guaranteed for 50 years against manufacturing defect. Franke taps are guaranteed against defective materials and workmanship for 1 year in relation to coatings and finishes, and 5 years in relation to moving parts. Franke will replace (and where appropriate repair) defective sinks. In relation to taps, Franke will where appropriate provide replacement parts for your taps or replace your taps. Any associated or ancillary costs to be incurred by you as a result of replacement of Franke sinks and taps under this guarantee shall in all cases be previously approved by Franke UK Limited.

This guarantee is in addition to and does not affect your statutory rights.